



***FIXED CHAMBER
ROUND BALERS***

FIXED CHAMBER ROUND BALER RANGE

HIGH PROFITABILITY

Crop harvesting is a delicate phase of considerable importance for the farmer which allows enhancing the nutritional and protein quality of the forage in the stable.

The range of fixed chamber balers by MASCHIO GASPARDO offers the best solutions guaranteeing high quality and reliable products, that meet both the needs of small farmers with simple and light models, up to professional models for large companies and contractors. A range consisting of low-maintenance equipment and maximum harvesting versatility: from wet to dry products and to delicate ones such as alfalfa.



CONTENTS

Feed Systems ...	4
Fixed baling chamber with bars	6
ENTRY 120-150	8
TROTTER 125	10
MONDIALE 110	12
MONDIALE 120	14
MONDIALE 120 COMBI	16
TECHNICAL SPECIFICATIONS	18

FIXED CHAMBER ROUND BALER BENEFITS



- versatility of use
- bales with a soft core
- usable with low power tractors
- excellent manoeuvrability and agility
- small size

FEED SYSTEMS

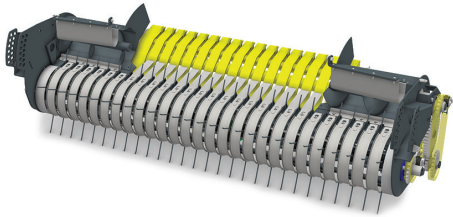

AVAILABLE FOR
ENTRY - TROTTER

ALTERNATIVE FEEDER

Ideal for short and dry chopped straw and to collect delicate and leafy forage, such as alfalfa, without damaging it.

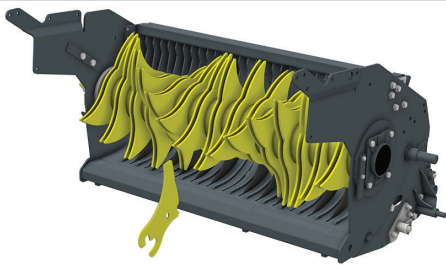

AVAILABLE FOR
TROTTER - MONDIALE

TOPCUT ROTOR

10 - 15 knives

The TOPCUT system cuts the product during harvesting, at a length of around 77 mm. This guarantees maximum harvesting efficiency and greater utilization of the baling chamber.

The fake knife kit is available.

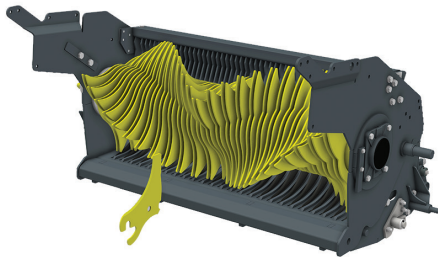

AVAILABLE FOR
TROTTER - MONDIALE

ULTRACUT ROTOR

25 knives

The high number of knives means it can cut hay to a length of 45 mm.

Ideal for green crops to be used as silage, it improves fermentation and reduces mixing time in the mixer wagon. The fake knife kit is available.



Fixed chamber

Always the maximum weight and density

Round balers are used all over the world in various harvesting situations: they must therefore be fully functional in multiple fields of use, with straw, hay or wilted silage.

The peculiarity of the fixed chamber is the creation of soft core bales, with the classic star shape.

This is determined by the fact that the product flows into the chamber gradually occupying all the space, with greater density towards the outside. With wet forage this guarantees enormous advantages, such as the loss of moisture for better storage.

Preservation of nutritional and protein quality

"Star core"

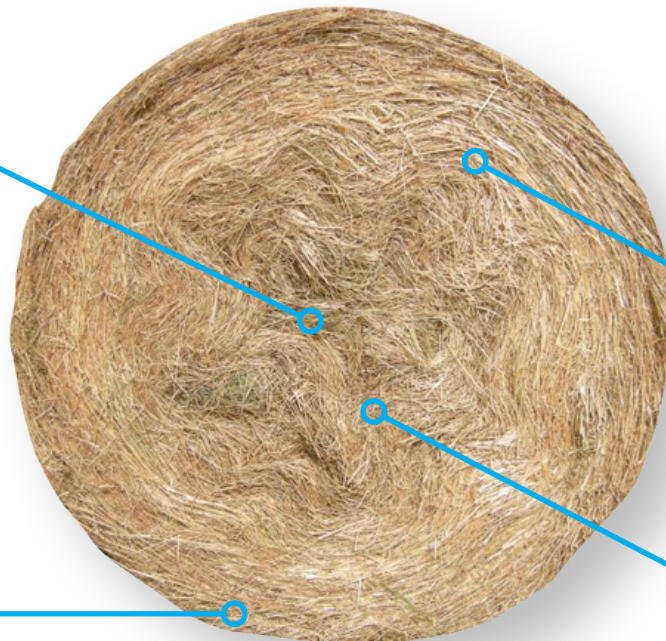

**Absence of mould
and anomalous
fermentation**



Loss of moisture

Higher external density

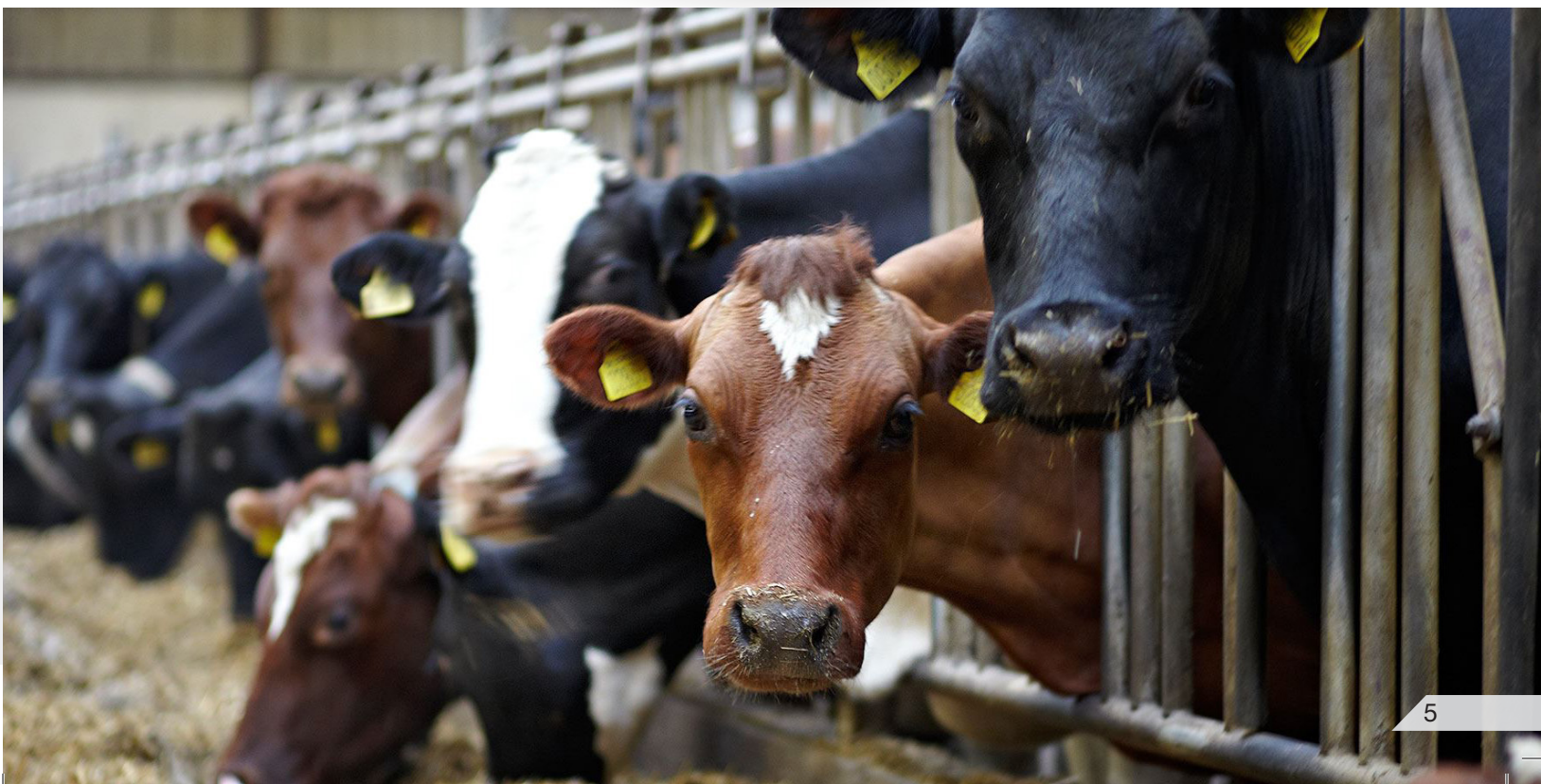

ENTRY 120 - 150

painstaking attention to detail

Fixed baling chamber with bars

A robust compression chamber with steel bars characterizes the ENTRY model as a fixed round baler with high collection versatility and high operating capacity. The round baler is made up of bars that allow constant bale formation, with a maximum adjustable pressure of 140 bar. The use of the bars allows high grip on the product, keeping the bale in rotation even with a very wet product. A sturdy feeder distributes the crop evenly in the chamber to produce perfect bales.



STEEL BARS

There are 33 bars in the ENTRY 120 model and 41 in the ENTRY 150 model, capable of pressing the product even when wet to form round bales that are compact and stable in shape.



BALE COUNTER

Bale counter with reset button to monitor daily production.

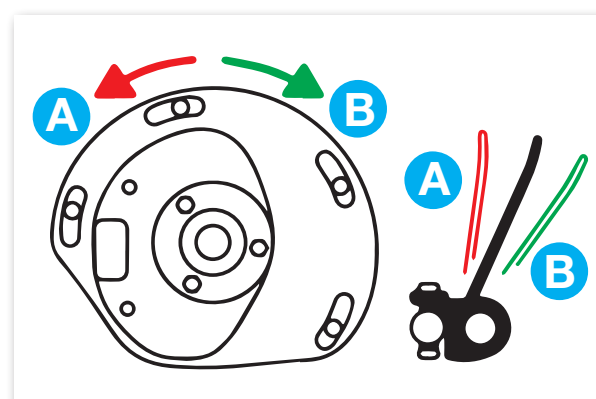

PICKUP ADJUSTMENT

The pickup cam can be adjusted in order to anticipate or postpone the collection of the product in the field, to adapt to the different types and humidity of the product.



MANUAL PRESSURE CONTROL

The pressure can be managed manually up to 140 bar.



ADJUSTABLE DRAWBAR

In an intuitive and quick way, it is possible to vary the height of the drawbar by acting on special adjustment screws, thus making it possible to combine it with tractors of different types.



PICKUP TYRES

The rubber tyres of the pickup guarantee regular movement on the ground, optimizing and guaranteeing a clean collection of the product, for perfect storage and maintenance of nutritional properties.



AUTOMATIC CHAIN OILING

The round baler is equipped with an automatic chain oiling system. It comes into operation each time the door is closed, by the movement of a mechanical pump.

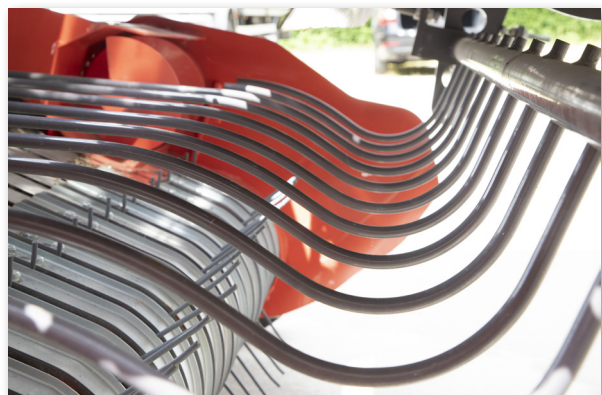

FRONT DEFLECTOR RAKE

ENTRY is equipped with a windrow compressor rake capable of pressing and conveying the product before entering the chamber, in a regular and uniform way. Through a pin system, it is possible to adjust the level of pressure and intensity on the product as well as the height.

ENTRY 120 - 150

from 40 to 50 HP - Fixed chamber round baler with bars



ENTRY 120

Small, but with high performance

The ENTRY 120-150 model has been designed to meet the needs of small and medium-sized farms that require a low maintenance fixed chamber round baler that is easy to use and can be combined with low power tractors. The baling chamber with bars is equipped with a reliable and strong chain system, guaranteeing a long life and good working capacity.

The different adjustments of the pickup and the windrow compressor rake make this machine suitable for the collection of different types of product, both wet and dry. The different standard features and its size, compact and with a low centre of gravity, make it optimal even in narrow spaces and hilly areas.



FEEDING AUGER

The lateral forage is gently conveyed to the feeder, so as to always obtain compact bales even at the edges. This guarantees the formation of bales that are stable in shape and can stand even a not very gentle handling, transport and long periods of storage.

BINDING SYSTEM

The machine can be requested with two types of binding: net and double twine (optional). Inside the round baler, by means of a pin adjustment, it is possible to vary the number of winding turns.



Compact, but with high performance!

**REINFORCED
CHAINS
WITH 1" PITCH**



ENTRY 150



BALE EJECTOR

Entry is equipped as standard with a bale ejector which facilitates manoeuvring during the unloading phase, increasing hourly productivity.

ELECTRIC CONTROL UNIT

Binding is carried out by means of a specific control unit, directly from the driver's seat. A clearly visible STOP light and an alarm indicate to the operator when the bale has reached the set density.



ENTRY	Power	Pickup	Bale width	bale Ø	Knives	Binding Type	Weight kg
	HP	mm	mm	mm	no.		
120	30 - 40	2000	1200	1200	-	Net (double twine option)	1900
150	37 - 50	2000	1200	1500	-	Net (double twine option)	2200

TROTTER 125

from 52 to 72 HP - fixed chamber round baler with rollers



TROTTER 125

Fixed chamber model with high performance

TROTTER 125 represents the entry level model of roller round balers, with an active conveying profile, capable of concentrating ease of use and high production capacities. This machine is equipped with robust mechanics, with gears and hardened roller pins: a chamber with 18 rollers capable of forming dense and regularly shaped bales with a diameter of 125 cm. This round baler is well-equipped with 220 cm pickup, automatic chain oiling and the possibility of choosing between 3 feeding systems. TROTTER is a multi-purpose round baler, agile in flat and hilly areas, suitable for all types of product, both dry and wet.

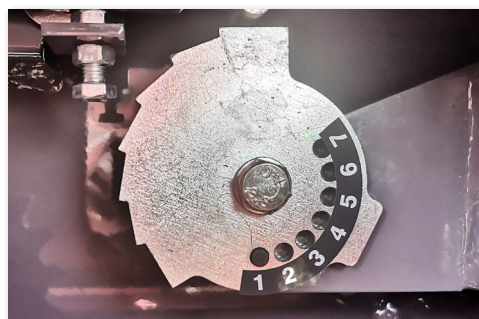

MANUAL BALING ADJUSTMENT

Depending on the product to be collected, it is possible to manually vary the pressure of the chamber through seven positions. The pressure selectors are located at the rear of the machine on both sides.

3 FEEDING SYSTEMS

The machine offers maximum collection versatility thanks to three feeding systems: alternative feeder, TOPCUT (13 knives) and ULTRACUT (25 knives). The cutting of the product guarantees better harvesting efficiency and greater exploitation of the baling chamber.



Suitable for all products

Hardened roller gears and pins

High pressure with steel rollers

REINFORCED CHAINS WITH 1" PITCH

Large pickup

Automatic chain oiling



EASYTRONIC TERMINAL

Through an intuitive terminal in the cab it is possible to manage and control alarms, sensors, binding and activation/deactivation of the knives. Control from the cab makes the operator's job even easier and faster.

VERSATILE WITH ALL PRODUCTS

Thanks to robust and reliable rollers, TROTTER is characterized by a high compression capacity. It is gentle on hay, perfect on wet forage, but also efficient on difficult products such as stalks and straw.



TROTTER	Power HP	Pickup mm	Bale width mm	bale Ø mm	Knives no.	Binding Type	Weight kg
125	38 - 52	2200	1200	1250	-	Net (double twine option)	2650
125 TOPCUT	48 - 65	2200	1200	1250	13	Net (double twine option)	3120
125 ULTRACUT	53 - 72	2200	1200	1250	25	Net (double twine option)	3220

MONDIALE 110

from 70 HP - fixed chamber round baler with rollers



MONDIALE 110

Simple and versatile solution

MONDIALE 110 is the fixed chamber round baler with rollers designed and developed for hills and mountains, particular conditions that require a compact machine with a low centre of gravity. The design of the rollers, with an active conveying profile, has been designed to ensure a secure and constant grip on all types of product, whether dry or wet, always keeping the bale being formed in rotation. In addition, the compact size and low weight allow it to be combined with low-power tractors, offering maximum manoeuvrability; this particular small shape also allows the harvesting of the vine shoots in the vineyard row.



MINIMUM IMPACT ON THE SOIL

Thanks to the rubber tyres, the pickup is light on the soil, ensuring a perfectly balanced harvesting and excellent conservation of the turf. The height adjustment is quick and easy, thanks to the movement of the pins in the different holes.

DROP FLOOR

Device that can be managed directly from the monitor in the cabin to facilitate the removal of any blockages, with a significant increase in productivity. By opening the bottom and inserting the power take-off it is possible to resolve the momentary stop.

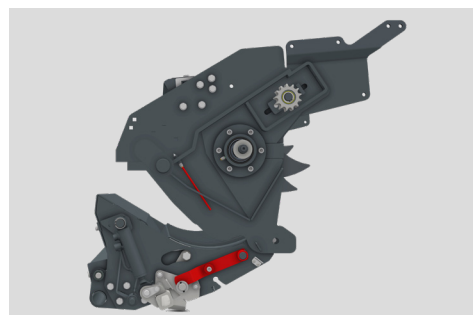

Suitable for any slope!

17 rollers with active conveying profile

Net binding system

Adjustable maximum pressure of 150 bar

4-bar pickup

REINFORCED CHAINS WITH 1" PITCH

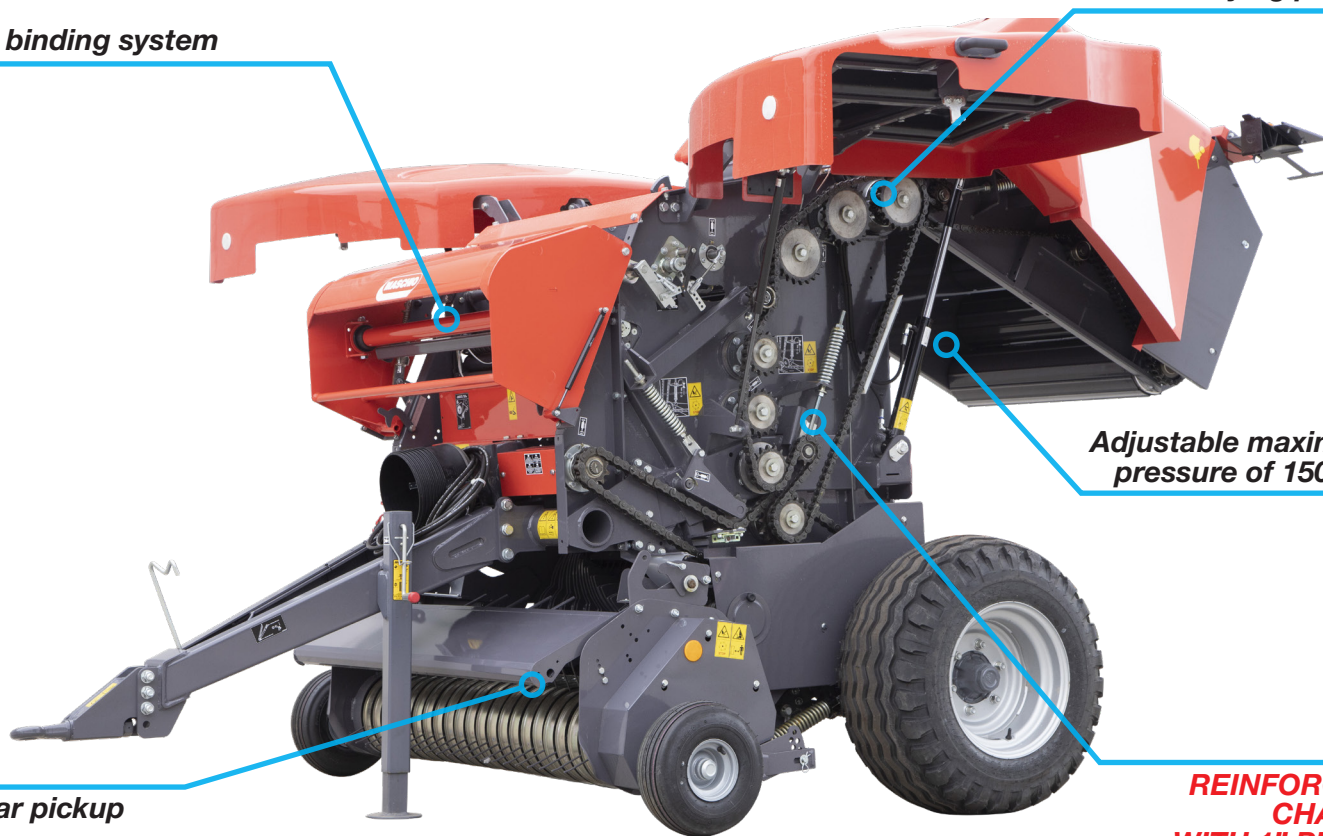

HEAVY-DUTY BEARINGS AND SUPPORTS

The rotatable roller bearings offer unbeatable strength to handle even the most demanding workloads. The watertight seal makes work safe even in the presence of dust and product.

INCREASED SAFETY

Each knife has a safety system and automatic spring reset which intervenes in the event of an impact with an external body. Greater safety even in the presence of stones, with a machine that is always performing.



TROTTER	Power HP	Pickup mm	Bale width mm	bale Ø mm	Knives no.	Binding Type	Weight kg
110 TOPCUT	52 - 70	1800	1000	1100	10	Net	2250

MONDIALE 120

from 102 HP - fixed chamber round baler with rollers



MONDIALE 120

Performing with all types of products

MONDIALE 120 is the fixed chamber round baler that allows you to enhance the harvested product thanks to a roller compression chamber with rotary feeder, which allows high productivity and excellent product storage. A regular flow inside the chamber allows you to operate at good speeds even on uneven ground, packing up to a maximum pressure of 180 bar. The presence of a knife cutting system allows you to obtain a uniform and denser bale, maximizing the space inside the baling chamber. MONDIALE 120 is a professional model, suitable for those who want a sturdy, reliable machine that can be managed entirely from the tractor cab. The quality of the materials and components used allows this equipment to perform in all collection conditions.



PICKUP

The large 220 cm pickup with 4 tine bars allows you to operate even in the presence of abundant and not perfectly regular windrows. The optional pivoting wheels allow you to follow the contour of the ground constantly, making it easier to turn.

CONSTANT OILING

MONDIALE 120 is equipped with an automatic chain oiling system with a rotary pump, which allows the round baler to be constantly oiled during work. The large and resistant brushes guarantee perfect lubrication.

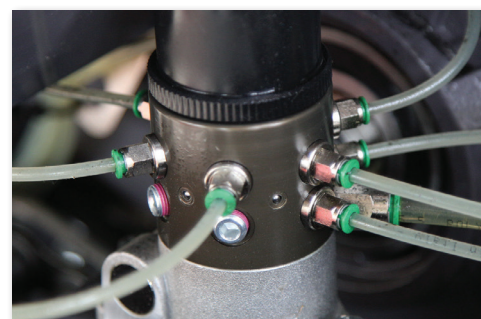

Maximum performance

15 or 25 knife cutting system

19 rollers with active conveying profile

Manual centralized greasing system

REINFORCED CHAINS WITH 1" ¼ PITCH

220 cm wide pickup

Drop floor



WINDROW COMPRESSOR ROLLER

MONDIALE 120 is equipped with a windrow compressor roller capable of pressing the windrow, ensuring high and constant speeds. This allows the product to be taken to the pickup before entering the chamber, in order to obtain regular and uniform feeding.

REINFORCED CHAINS

To guarantee a machine that is always performing and meet the various needs of contractors who subject the machines to prolonged stress, MONDIALE 120 is equipped with 1" ¼ reinforced chains capable of withstanding the heaviest stress. Fewer interruptions for the operator thanks to automatic oiling.

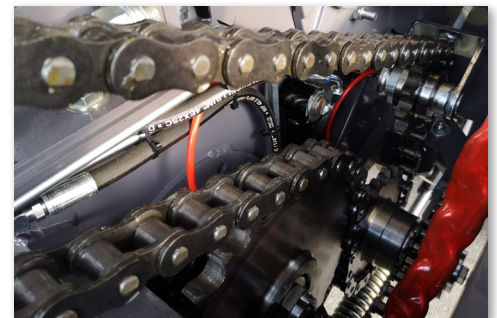

MONDIALE 120	Power HP	Pickup mm	Bale width mm	bale Ø mm	Knives no.	Binding Type	Weight kg
120 TOPCUT	75 - 102	2200	1200	1200	15	Net	3665
120 ULTRACUT	76 - 102	2200	1200	1200	25	Net	3790

MONDIALE 120 COMBI

from 110 to 130 HP - round baler with combined fixed chamber



Packs and wraps in one step

MONDIALE 120 COMBI is the fixed chamber round baler with rollers that represents the perfect solution for baling and wrapping operations with a single machine. During harvesting, the product is cut, baled and wrapped in a single operation, considerably reducing the stay in the field and improving the quality characteristics of the product. A single pass in the field reduces trampling, working time and fuel consumption.

MONDIALE 120 COMBI is a fully automatic machine in all its functions, available with two cutting systems, two types of binding and one of the fastest double satellite wrappers on the market.



NEW FILM BINDING

The machine can be equipped with plastic wrap binding which allows a saving of the same and a reduction in packing times. Before cutting, a hydraulic cylinder allows to shrink the film obtaining a clean cut. With the new binding system it is possible to use film rolls of variable width, from a minimum of 1230 mm to a maximum of about 1400 mm, improving the cover of the bale and obtaining a coverage effect.

LATEST GENERATION WRAPPER

The wrapper consists of a 3-roller platform, 2 winding machines for 750 mm film and automatic film cutter. The 3 motorized rollers allow a continuous and regular rotation. A specific sensor checks for any breaks in the plastic wrap, compensating for the missing film turns of the other arm. Once wrapped, the bale is ejected and left on the ground or it can be tipped over.



All in one step



MONDIALE 120 COMBI



EVERYTHING UNDER CONTROL

The operations are managed directly from the tractor cab, from which it is possible to manage the functions of both the round baler (pickup, maximum pressure of 190 bar and bale binding and unloading) and the wrapper (number of revolutions, rotation speed, unloading) with the possibility of using all automated operations.

WHY WRAPPING or ENSILING?

Silage allows the harvesting to be preserved for longer, offering the animal a high quality nutritional product free from contamination derived from soil, dust and adverse climatic conditions. The silage does not need to be dried, thus allowing the farmer to collect the product at any time, saving time. Thanks to the protective plastic wrap, bales can also be stored in the field.



MONDIALE 120 COMBI	Power	Pickup	Bale width	bale Ø	Knives	Binding	Weight	Motorized rollers	Aluminium film stretcher	Film cutter
	HP	mm	mm	mm	no.	Type	kg	no.	Type	Type
CUT	80 - 110	2200	1200	1200	15	Net *	5900	3	2 X 750mm	Automatic
ULTRACUT	95 - 130	2200	1200	1200	25	Net *	5980	3	2 X 750mm	Automatic

* plastic wrap (option)

		ENTRY		
	<i>UOM</i>	120	150	120
BALE SIZE				
<i>Diameter</i>	<i>mm</i>	1200	1500	
<i>Width</i>	<i>mm</i>	1200		
PICKUP				
<i>Pickup width</i>	<i>mm</i>	2000		
<i>Number of tine bars</i>	<i>no.</i>	4		
<i>Wheels</i>		Fixed		
<i>Windrow compressor rake</i>		Standard		Stand
<i>Windrow compressor plate</i>		-		-
<i>Roller baffle</i>		-		
BALING CHAMBER				
<i>Type</i>		Bars		
<i>Bars/Rollers</i>	<i>no.</i>	33	41	
<i>Bale ejector</i>		Standard		
FEEDING				
		Feeder		Feed
<i>Cutting length</i>	<i>mm</i>	-	-	-
<i>Knife protection</i>		-		-
<i>Rotor shut-off</i>		-		
<i>Drop floor</i>		-		
BINDING				
<i>Type</i>		Net (double twine option)		
<i>Plastic wrap</i>		-		
Terminal				
<i>Type</i>		Electric control unit		
LUBRICATION				
<i>Automatic oiling</i>		Standard		
<i>Greasing</i>		Manual		
<i>Tyres</i>		11.5/80 - 15.3		
<i>Opt</i>		400/60 - 15.5		
<i>Weight</i>	<i>kg</i>	1900	2200	265



TROTTER			MONDIALE				
125	125 TOPCUT	125 ULTRACUT	110 TOPCUT	120 TOPCUT	120 ULTRACUT	120 COMBI TOPCUT	120 COMBI ULTRACUT
1250			1100	1200			
1200			1000	1200			
2200			1800	2200			
4				4			
Fixed			Fixed	Fixed	Fixed (Pivoting option)		
Standard	-		-				
-	Standard		Standard				
	-		-	Standard			
Rollers			Rollers	Rollers			
18			17	19			
Optional extra				Optional extra			
Feeder	13-knife rotor	25-knife rotor	10-knife rotor	15-knife rotor	25-knife rotor	15-knife rotor	25-knife rotor
-	77	45	100	77	45	77	45
-	Spring		Spring	Spring			
	Standard		-	-			
	-		Standard	Standard			
Net (double twine option)			Net	Net	Net (plastic wrap option)		
Optional extra			-	-	Optional extra		
EASYTRONIC			ICON	ICON	MONITOR		
Standard			Standard	Standard			
Manual			Manual (automatic option)	Manual centralized (automatic option)			
400/60 - 15.5			15.0/55-17	400/60 - 15.5		600/55 - 26.5	
11.5/80 - 15.3 or 19.0/45.17			400/60 - 15.5	19.0/45 - 17 and 550/45 - 22.5		700/55 - 26.5 and 800/55 - 26.5	
2650	3120	3220	2250	3665	3790	6300	6400





MASCHIO GASPARDO S.p.A.

Headquarters and production plant
Via Marcello, 73

I-35011 Campodarsego (PADUA) - Italy
Tel. +39 049 9289810 - Fax +39 049 9289900
info@maschio.com - www.maschio.com

Production plant

Via Bredina 6
I-26100 CREMONA (CR) - Italy
Tel. +39 0372 564610 - Fax +39 0372 564625

08-20 Code W00226681R
MASCHIO GASPARDO Marketing Dept.

For printing reasons, some pictures and images do not show the "EC" safety guards. Technical data and models shown in this catalogue are not binding. We reserve the right to revise the contents of this catalogue, to amend or improve the specifications without notice.