



***DISC CULTIVATOR  
RANGE***

# DISC CULTIVATOR RANGE

MASCHIO's range of Disc Cultivators provides a strategic solution for management of surface residues and alignment of land at depths between 10 and 15 cm.

The range of Disc Cultivators comprises 3 models: VELOCE, UFO TZAR and ADMIRAL. They share the high gap between the element and the carefully designed spaces of the frame, thereby allowing work speeds between 12 and 15 Km/h to the benefit of efficiency and operating performance.



## AGRONOMIC BENEFITS

### ***Incorporation of residues***

Unlike conventional tillage, using disc assembly limits soil turning only to the top 10-15 cm, thereby ensuring an increase in organic substance on the surface. The surface residue is cut and re-mixed with the soil to create an optimal environment for the development of micro-organisms and improvement in soil fertility.

### ***Resetting the structure of the soil***

In the long term, working only a single stratum active to a depth of 15 cm also improves the structure of the soil, making it richer in Organic Substance: The land thereby becomes ideal for easier refining as well as for the development of crops.

### ***Weed control***

To achieve maximum potential yield, the growth of weeds must be fully controlled while using the least possible chemicals to ensure economic and environmental savings.

# INDEX

VELOCE Surface disc cultivator	4
UFO TZAR Combined cultivator	12
ADMIRAL Combined cultivator	20



## **ECONOMIC BENEFITS**

### ***Higher profitability***

Efficiency, versatility and lower consumption are the features shared by Maschio Gaspardo disc systems built in close cooperation with farmers: in this way, minimum tillage concepts are merged to reduce management costs and processing times.

# VELOCE

## Surface disc cultivator

VELOCE

### **VELOCE - fast in name and fact!**

VELOCE is a lightweight disc assembly ideal for managing crop residues and refining the land to prepare the seed bed and bury liquid fertilizer. Thanks to 800 mm of rank spacing, optimal soil flow is assured in every working condition.

## MODELS AVAILABLE



### **Mounted, fixed frame**

Fixed frame versions are available measuring 2.5 to 4 m. Hydraulic adjustment of the standard roller makes it easy to achieve the correct work depth. Effective on the soil and efficient in the open field, they ensure optimal production capacity and reduced consumption thanks to high speed operations of up to 15 km/h.

VELOCE	Tractor power HP	Working width (cm)	Transport width (cm)	Working depth (cm)	N° discs (Ø - n)	Weight (kg)*
200	65-75	185	200	3 - 10	510 - 14	1145
250	80-90	250	255	3 - 10	510 - 20	1480
300	100-110	300	300	3 - 10	510 - 24	1665
350	120-130	350	345	3 - 10	510 - 28	1835
400	140-150	400	405	3 - 10	510 - 32	2005

\* with cage roller



**Mounted, folding frame**

Folding models available from 4 to 6 m with hydraulic roller work depth adjustment are an optimal compromise between compactness and work capacity (up to 6 metres!).

<b>VELOCE MOUNTED</b>	<b>Tractor power HP</b>	<b>Working width (cm)</b>	<b>Transport width (cm)</b>	<b>Working depth (cm)</b>	<b>N° discs (Ø - n)</b>	<b>Weight (kg)*</b>
<b>400</b>	120-160	400	300	3 - 10	510 - 32	2690
<b>500</b>	150-200	500	300	3 - 10	510 - 40	3065
<b>600</b>	180-240	600	300	3 - 10	510 - 48	3380

\* with cage roller



**Semi-mounted, folding frame**

The semi-mounted model is the version complete with transporter carriage for 5 to 7 metre versions. Convenient and easy to handle, it allows combination with less powerful tractors. Even greater freedom of movement means that the disc set can better follow the profile of the land to ensure optimal working.

<b>VELOCE SEMI-MOUNTED</b>	<b>Tractor power HP</b>	<b>Working width (cm)</b>	<b>Transport width (cm)</b>	<b>Working depth (cm)</b>	<b>N° discs (Ø - n)</b>	<b>Weight (kg)*</b>
<b>500</b>	160-220	500	300	10	40	6450
<b>600</b>	200-260	600	300	10	48	6900
<b>700</b>	240-320	700	300	10	56	7350

\* with double U roller

# Versatility at the highest levels

## Multiple advantages for every need

Thanks to its impressive versatility and sturdiness, VELOCE can be used in any situation: from working stubble on hard ground to burial of the cover-crop and refining the land after ploughing to ensure versatility all year round.



## Depth management

The front of the machine has a plate with a graduated scale clearly visible from the cab of the tractor that continuously indicates the depth at which the machine is working, thereby improving operator comfort.



Zone 1

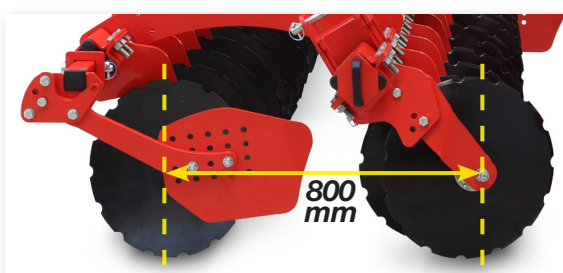

## Zone 1

The two 510 mm rows of discs mean that the soil profile can be worked to a depth of 10 cm.

The distance between the two rows has been increased to 800 mm to ensure optimal soil flow even in the presence of residues, thereby allowing work-speeds of up to 15 km/h while perfectly mixing the soil and the residues.

**No imperfection**

A new solution has been developed to improve lateral refining in tillage work: a square guard in place of the classic disc. It is easy to set and ensures complete retention even when large amounts of residue are involved. If the right settings are made before commencing work, no line or furrow will be seen between one pass and the next.



**Hydraulic setting**

The work depth is adjusted by the rear roller by means of an hydraulic system managed by the operator comfortably from the cab of the tractor even during the task itself, thereby making continual variations possible.

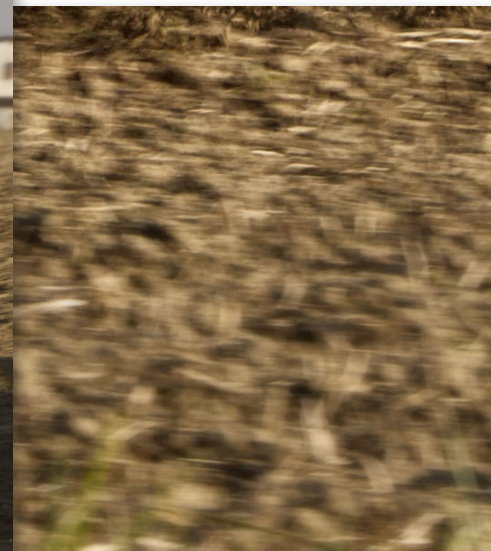

**Zone 2**

**Zone 2**

The land worked by the two rows of front discs is compacted by the rear roller to ensure the best conditions for uniform sowing. Thanks to the huge range of rollers available, a solution for every type of land is within easy reach.

# Effective discs

**VELOCE**



## Compact work front

The discs are mounted on independent suspensions and are spaced by 25 cm as well as staggered over the two rows to provide a very aggressive work front that at the same time ensures optimal flow of soil and/or residue in very work condition.

## Oversized discs

VELOCE discs are in high-strength boron steel to ensure the least possible wear even on tenacious ground. The 510 mm diameter ensures a work depth of around 10 cm that is ideal for burying residues as well as refining clods. Reduced convexity ensures great soil penetration simplicity on a par with the power absorbed.

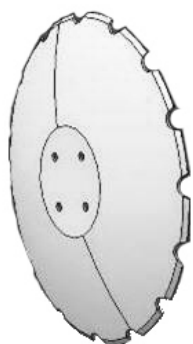
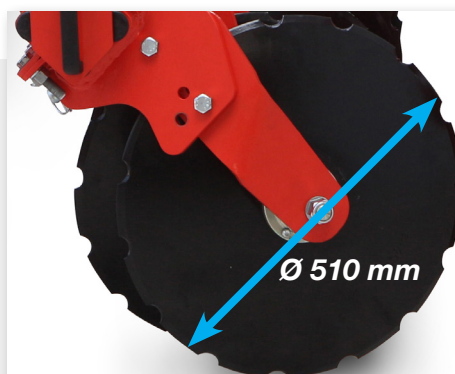

## Disc with 15 teeth

Ideal for surface refining of the land and seed bed preparation.

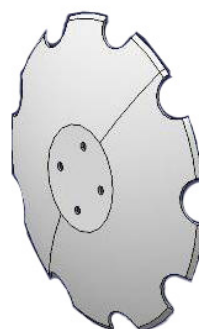

## Disc with 9 teeth

Very aggressive and incisive. Ideal for surfaces rich in residue.





**AGRIHUB - cutting maintenance levels!**

The hubs on each disc are hinged on special spherical bearings. The bearing is protected against dust, mud and dirt by a special gasket and a bolted cover to ensure maximum reliability. The hub is designed to ensure the best Performances and minimal maintenance: there is no need to grease the individual discs at regular intervals!

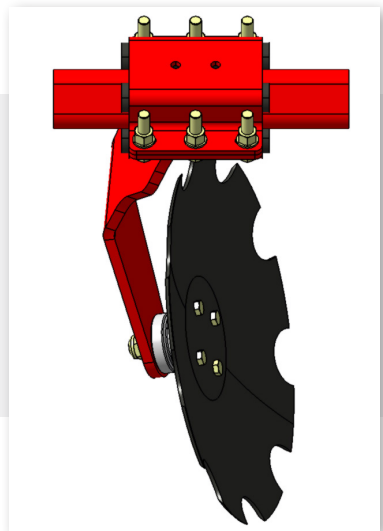

**No compromises**

To ensure maximum work quality above and below the surface, every disc is mounted on its own support with a "Silent Block" shock absorber.

**Designed in the tiniest detail**

The disc support is designed to facilitate maximum soil flow inside and outside the disc, especially at high speeds. The slightly curved shape improves absorption of roughness for even better working stability.

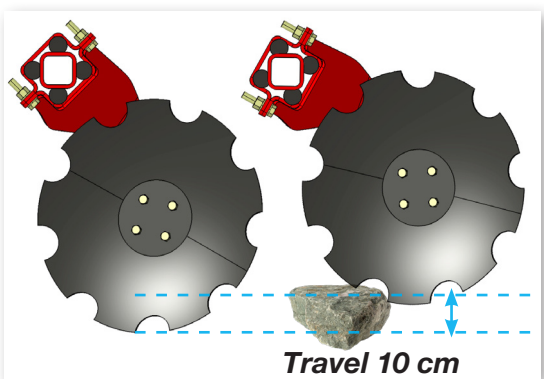

**Silent block**

Optimal compromise between compactness, weight and performance, every VELOCE disc has a specific Silent Block shock absorber system: The 4 high strength rubber cylinders absorb flexibility to ensure stiffness across the entire set of disks and thereby the capacity to absorb land roughness. This system does not require any kind of maintenance and greasing.

# Select the roller best suited to your farm

VELOCE



Ø 600 mm

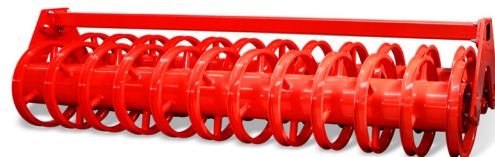

Ø 560 mm

## **Ring roller and U roller**

These roller models offer maximum in-use versatility, especially on wet land that has to be levelled and consolidated without excessive compaction. Compact bands alternating with unworked bands are created on the ground that encourage the exchange of air and water while avoiding the formation of surface crusts or stagnant water.

## **Cage roller**

Ideal for dry ground, providing good refining and surface levelling. The Ø 600 mm diameter is ideal for reducing excessive clods. The limited weight reduces the rear overhang for better hook-up with lightweight tractors.



Ø 600 mm



Ø 600 mm



Ø 600 mm

## **Rubber roller**

Ideal for dry and even heavy ground; helps develop an optimal seed bed by creating a compact surface stratum. The moisture in the soil is trapped and allows rapid germination of the crop. It is especially indicated for sowing cereals with 12.5 cm rows.

## **PACKER ROLLER**

Ideal for dry and even heavy ground; the Packer roller helps develop an optimal seed bed by obtaining a compact surface stratum. After the pass, the soil retains moisture to promote rapid germination of the crop.



**Multi-purpose scattering**

For sowing coverage crops in a single pass or to integrate nutrients, Maschio Gaspardo offers the application of a scatter sowing kit. The hopper (400, 500 and 600 litres) ensures reasonable work autonomy and - thanks to the rear access ladder - refilling is fast and safe. An interchangeable roller distributor is placed under the hopper to spread seeds or fertilizer. The electric or hydraulic doser can dialogue with the tractor's GPS for automatic dosing control.

**On-road transport (3 metre version)**

The outermost pairs of discs can be folded inwards during transport to ensure that the equipment lies within on-road circulation limits. This solution was necessary in order to allow an effective working width of 3 metres.

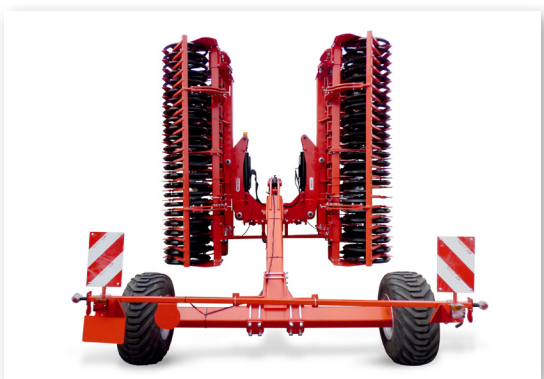

**On-road transport (folding versions)**

For on-road transport, mounted and semi-mounted versions are fitted with hydraulic frame locking for an overall width of just 3 metres.

# UFO TZAR

## Heavy-duty disc cultivator



**UFO TZAR**

### **Residue... NO PROBLEM!**

UFO is a disc cultivator for intensive work on land and residue. The sturdy structure together with a 610 mm disc set ensures improved application versatility in reaching a work depth of 15 cm.

## MODELS AVAILABLE



### **Fixed frame**

Available with working widths of 2.5 to 4 m, the fixed frame UFO model ensures excellent performance thanks to its tubular structure combined with broad spacing of disc ranks.

All fixed models are equipped with oscillating springs having a cross-section of 40x40 mm.

<b>UFO - FIXED FRAME</b>	<b>Tractor power HP</b>	<b>Working width (cm)</b>	<b>Transport width (cm)</b>	<b>Working depth (cm)</b>	<b>N° discs (Ø - n)</b>	<b>Weight (kg)*</b>
<b>250</b>	80-90	250	255	10	610 - 20	1480
<b>300</b>	100-110	300	300	10	610 - 24	1665
<b>350</b>	120-130	350	345	10	610 - 28	1835
<b>400</b>	140-150	400	405	10	610 - 32	2005



### 360° application

Designed multi-purpose 360° applications, UFO's frame combines sturdiness and flexibility: The two ranks spaced by 1000 mm ensure optimal soil flow, while narrow and staggered discs (25 cm on the 2 ranks) ensure excellent refining of the soil and surface residue management. The large free space together with C-shaped springs mean that work is possible even in the most difficult conditions.



### Folding frame

UFO is available as a semi-mounted or towed folding version of 4 to 6 m in width. Maximum productivity thanks to high work speeds and a work width of up to 6 m.

The entire range is equipped with C-shaped spring supports having a cross-section of 80 x 20 mm.

UFO - FOLDING FRAME	Tractor power HP	Working width (cm)	Transport width (cm)	Working depth (cm)	N° discs (Ø - n)	Weight (kg)*
400	100-160	400	300	08-12	610 - 32	3190
500	125-200	500	300	08-12	610 - 40	3710
600	150-240	600	300	08-12	610 - 48	3990

# Versatility at the highest levels

## **A lethal combination**

The combination of c-shaped spring, Culti-Hub and  $\varnothing$  610 mm disc allows all the power of the tractor to be exerted on the ground as well as soil refining enhanced by the high work speed (ideal at around 15 km/h).



## **Containment under control**

On both outer sides of the disc set there are two containment discs that can be adjusted in relation to height and angle: they help maintain the flow of soil inside the equipment's work front.



**Zone 1**

## **Zone 1 - Cutting and mixing**

The two rows of front discs separated by 1000 mm cut the ground and bury the residue. The 25 cm spacing between discs in the same row ensures appropriate flow of product, while the arrangement of the two rows is staggered by 17.5 cm to ensure high work uniformity even at depth.

**Easy adjustment for maximum pull**

The solution with two rows of discs in line simplifies setting operations. Having made sure that the machine works at right angles to the ground, the opposing arrangement of the discs eliminates possible drifting effects for maximum working comfort and ease of use.

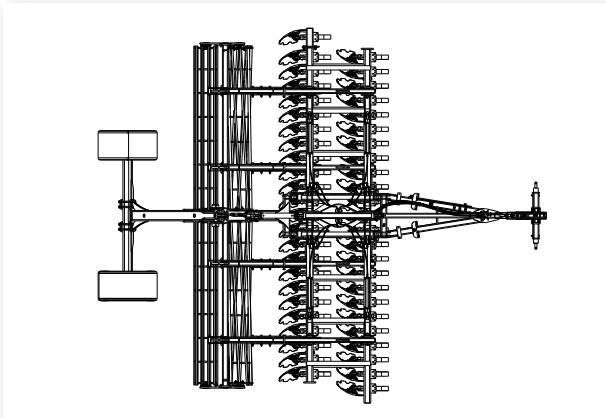

**Working depth**

The equipment's work depth can be adjusted between 6 and 15 centimetres using manual roller pin adjustment. The work depth increases when the lower pin is engaged in a lower hole and decreases when the same pin is engaged in a higher hole.

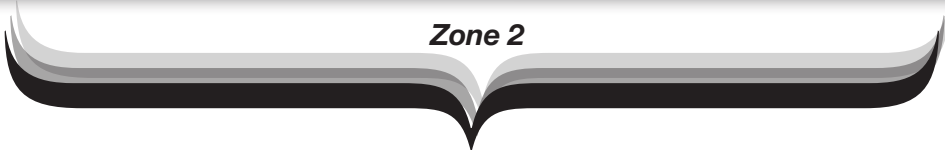

**Zone 2**

**Zone 2 - Levelling and refining**

The vibrating effect generated by the support of the dual pivoting roller, combined with the different rotation speed of the two rollers in view of their different diameters (460 mm and 430 mm), creates an amplified breaking effect that significantly reduces surface clodding. The pivoting system means that the ground is tracked more uniformly for better soil levelling.

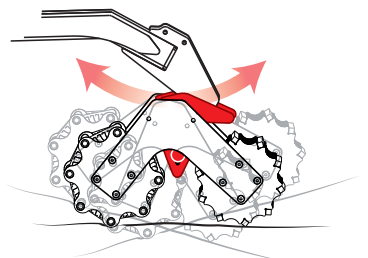

**PIVOTING ROLLER FOR BETTER SOIL LEVELLING**

# Work units

UFO

## The disc

The 610 mm disc ensures a work depth up to 15 cm, ideal not only for burying residue but also for refining the soil, for example after ploughing. Two disc versions are available depending on the amount of residue:

- large amount of residue (crownwheel with 9 grooves)
- small amount of residue (crownwheel with 15 grooves).

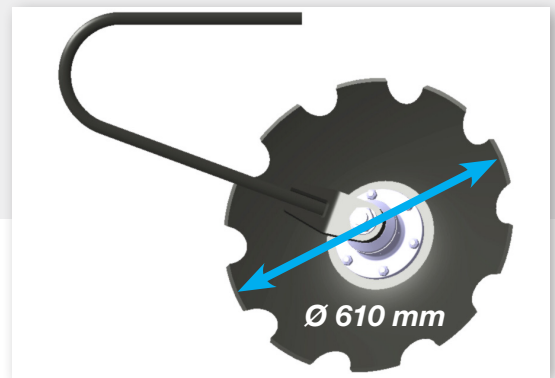

## New C-Shaped Spring

UFO's support and shock absorber system combine to create the "C-Shaped Spring". Compact design ensures optimal flow of material between the discs, while the special steel for springs used ensures reliability and flexibility even in heavy-duty conditions.

The spring is designed to be strong yet free to vibrate, capable of absorbing high speed stresses and then discharge them as a vibration effect that amplifies soil refining.

There is no need for maintenance, thereby reducing downtimes and running costs.

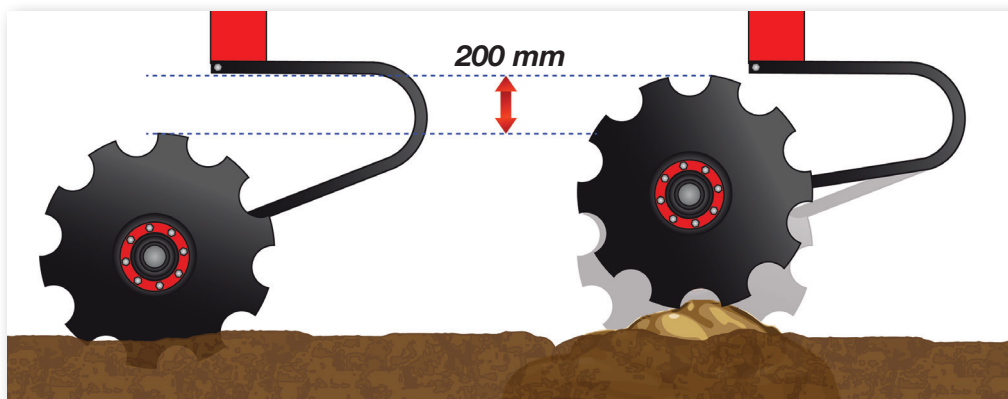





**CULTI-HUB: performance and reliability**

The disc hubs fitted to UFO are characterised by extremely high performance in all work conditions.

**Heavy duty bearing**

UFO is fitted with an oblique, dual crown ball bearings just like those used on truck and trailer axles.

**Duo-cone**

Maximum protection against external agents thanks to the Duo-Cone seal: two opposing tapered metal rings separated by a thin film of oil - as already used in heavy duty machinery such as excavators and augurs.

**Lubrication**

Oil bath lubrication protects moving organs against excessive friction and reduces routine maintenance times.

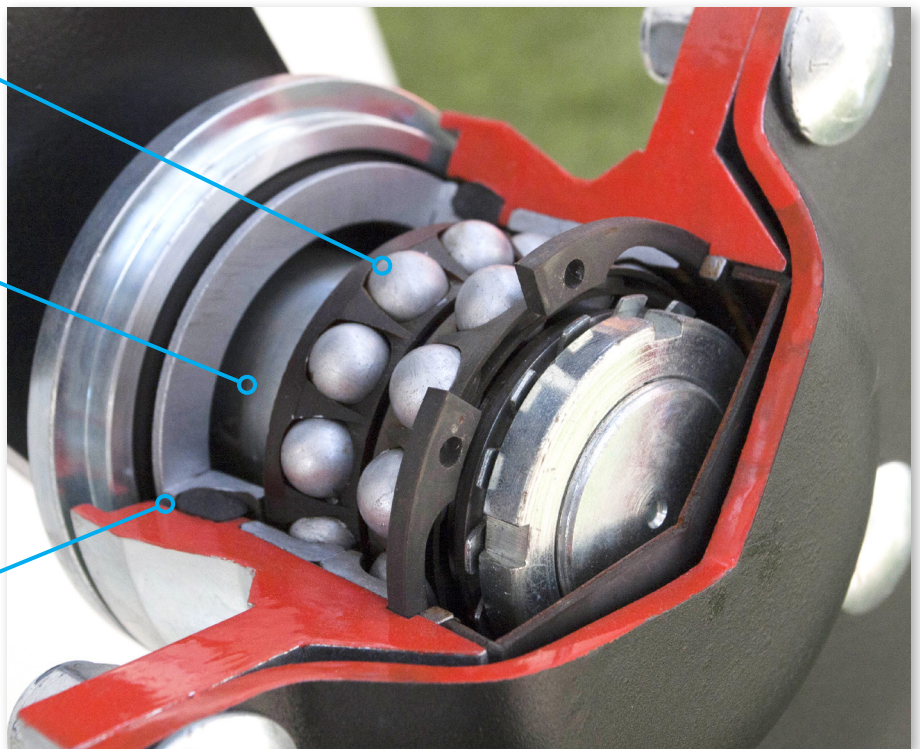

# Select the roller best suited to your farm

UFO



Ø 600 mm

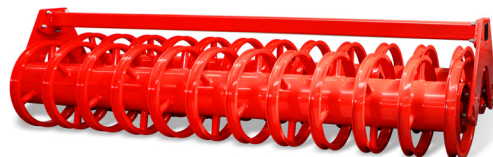

Ø 560 mm

## Ring roller and U roller

These roller models offer maximum in-use versatility, especially on wet land that has to be levelled and consolidated without excessive compaction. Compact bands alternating with unworked bands are created on the ground that encourage the exchange of air and water while avoiding the formation of surface crusts or stagnant water.

## Cage roller

Ideal for dry ground, providing good refining and surface levelling. The  $\varnothing$  600 mm diameter is ideal for reducing excessive clods. The limited weight reduces the rear overhang for better hook-up with lightweight tractors.



Ø 600 mm



Ø 600 mm

## Rubber roller

Ideal for dry and even heavy ground; helps develop an optimal seed bed by creating a compact surface stratum. The moisture in the soil is trapped and allows rapid germination of the crop. It is especially indicated for sowing cereals with 12.5 cm rows.



Ø 600 mm

## PACKER ROLLER

Ideal for dry and even heavy ground; the Packer roller helps develop an optimal seed bed by obtaining a compact surface stratum. After the pass, the soil retains moisture to promote rapid germination of the crop.



**2-point pivoting hitch**

The rigid (semi-mounted) and folding versions of UFO are equipped with a 2-point pivoting hitch allowing a steering angle of 180° as well as excellent manoeuvrability during end of field turning and on-road transport.

**Towed version**

If requested, a rigid Heavy Duty CAT 4 ø 62 mm eyebolt is available for towed versions of the machine.

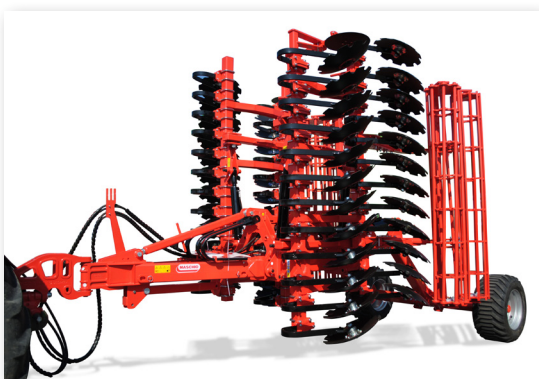
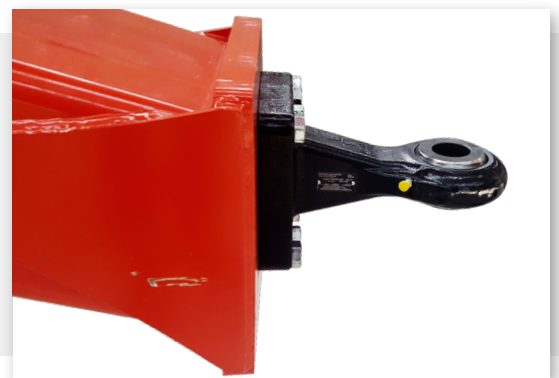

**Enclosed in just 3 metres**

For on-road transport, semi-mounted versions are fitted with hydraulic frame locking for an overall width of just 3 metres. To reduce compaction of the ground in headlands, oversized 700/40-22.5 wheels can be requested. depending on the Highway Code, an hydraulic or pneumatic braking kit can be selected.

# ADMIRAL Heavy-duty disc set



**ADMIRAL**

### ***A unique version for important requirements***

ADMIRAL is only available as a 8.50 m version capable to meeting the needs of farmers in very demanding conditions of use.

### ***4 seasons, always in the field: not just a run-of-the-mill disc set!***

- Broad free space between discs: high versatility
- High clearance maximum flow
- 4 rows of discs for intensive soil refinement
- Large diameter discs: complete burial of residue
- Combined rear section (toothed harrow + roller): optimal levelling



**MAIZE**



**SOY**



**WHEAT**



**RICE**



**COVER CROPS**



**REFINING**



**Extreme Performance**

Designed for large farms, ADMIRAL is a disc set conceived by Mascho Gaspardo for the most extreme working conditions. The need for ever larger working ranges makes ADMIRAL the perfect choice for this demanding task.

The "extreme" features of its disc set make it versatile in every situation: from cold, heavy land to wet and peaty sites with high residue even in the presence of shale.



<b>ADMIRAL</b>	<b>Working depth</b> cm	<b>Overall width</b> cm	<b>Transport width</b> cm
	<b>850</b>	8-15	850

\* with rollers \*\* without rollers

Transport height cm	Length * m	Work speed Km/h	Folding frame Sections	Power required HP	Discs No.	Weight ** (kg)
430	10,2	12	3	280 - 360	68	9400

**Clearly visible, hands-on results!**

Its 68 discs fear no obstacle: the cut, mix and bury for always efficient results.



# Designed for large sites

## **Thinking big**

The solid, sturdy frame takes the concept of conventional disc sets to extreme levels: the outcome is a unique attachment. Along the frame after the drawbar, there are 4 ranks of 610 mm discs spaced 50 cm from each other. At the rear of the disc set, a toothed harrow manages the flow of soil. Lastly, a roller uniformly flattens and levels the surface. In the middle, a row of large-diameter wheels helps maintain the required work depth.



## **Drawbar with shock absorber**

In order to lessen stresses on the drawbar and the tractor hitch, the drawbar on the ADMIRAL system has a safety spring shock absorber which protects the structure during work and transport stages alike.



**Zone 1 a**

## **1a and 1b - Unstoppable disc set**

The disc set is fitted with 4 rows of discs arranged in pairs spaced 1000 mm from each other. The 68 discs are fitted every 50 cm inside the same row and staggered by 25 cm between 2 rows. The overall effect of the 4 rows combined ensures a good compromise between refining and versatility.

**Assured performance**

To ensure even easier adjustment and effective pull, the disc layout is designed to cancel out any possible lateral drift effects.

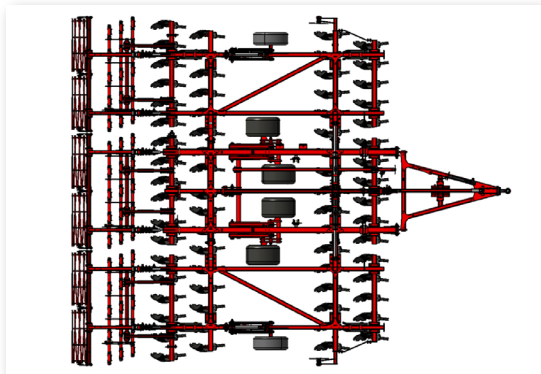
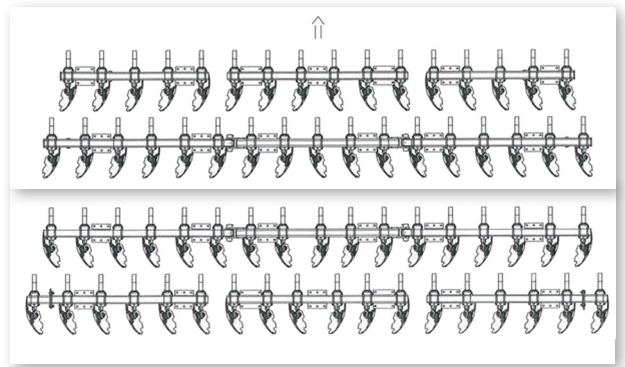

**Unique on the market!**

Thanks to the design of the dual pair of disc sets fitted in sequence, ADMIRAL introduces a new concept for minimum tillage machinery. a single pass effectively mixes and buries soil and stubble. The breaking action on soil and residue makes ADMIRAL a unique item of equipment on the market.



**Zone 2**

**Zone 1 b**

**Zone 3**

**Zone 4**

**2 - Depth under control**

The central section has 4 pairs of tandem wheels for a precise response to bumpy ground while maintaining the correct work depth up to 15 cm.

**3 - Designed for high speeds**

The rear section is fitted with a toothed harrow (70 cm) arranged over 3 rows in order to manage the high flow of soil and redistribute it uniformly.

**4 - Surface reconsolidation**

A rear roller flattens and reconsolidates the surface to leave the ground perfectly levelled.

# Disc/Hub/Spring

**ADMIRAL**

## **Aggressive profile**

ADMIRAL is fitted with a slightly concave 610 mm disc that always ensures an effective cut on any type of surface.

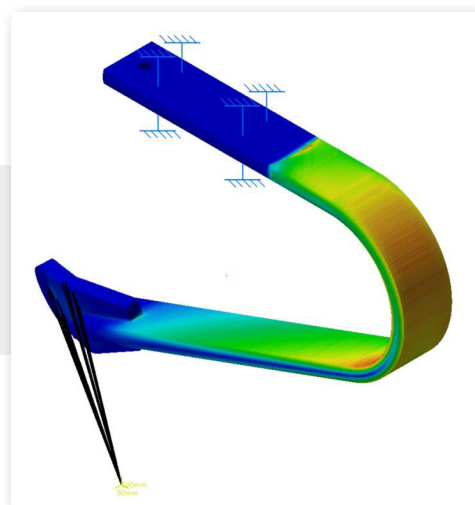
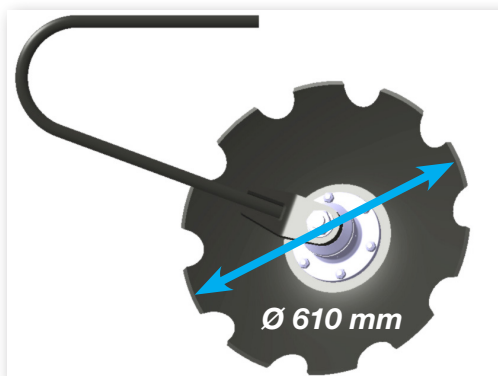

## **Tested on everything!**

To ensure maximum performance and reliability, the "C-shaped spring" in special high-strength steels for such springs was developed after extensive stress tests to improve resistance to stress and then return to the initial position.

## **"C-shaped spring": sturdy yet flexible**

Each disc has a spring shock absorber designed specifically to ensure flexibility and sturdiness. This special C-shaped spring ensures a large free clearance and high vertical travel (20 cm) so that every kind of obstacle can be overcome.

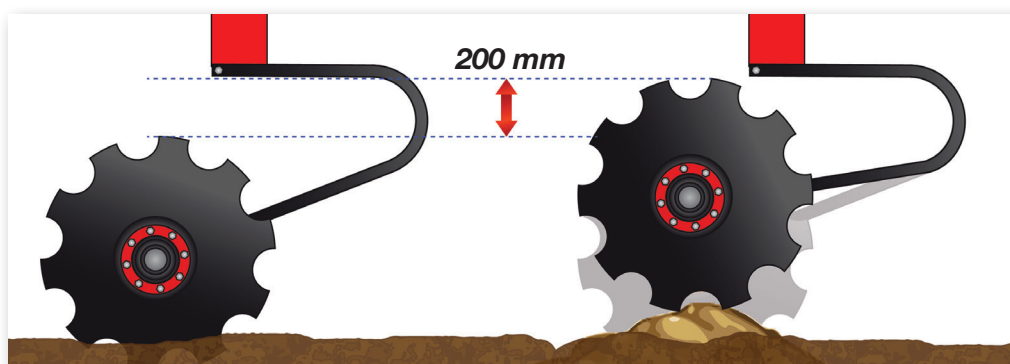





**360° protection**

Each disc is installed on special, oversized "CULTI-HUBS" to ensure even more reliability. The 2 taper bearing are immersed in an oil bath and protected by a special system of seals against water and mud.

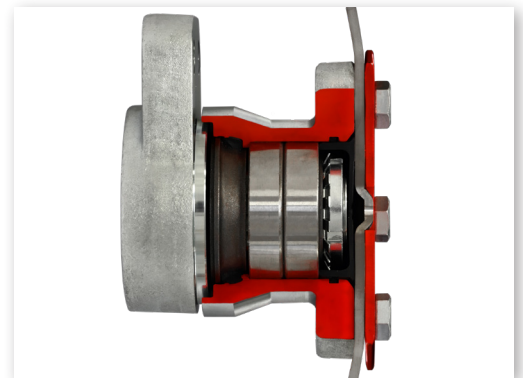

**Simple and reliable**

The disc set work depth is managed by the depth wheels in the central section. A mechanical stop regulates the piston travel limit and sets the depth in relation to work requirements. Convenient adjustment using the handle located in a frontal position.

**Adjustment of wings and main body**

If the work depth is not the same across the entire work front, the height of the side wheels must be adjusted.

If the work depth of the wings is less than that of the central frame, the mechanical tie-rod must be used to shorten the "L" and transfer more weight towards the external part.

On the contrary, if the work depth of the wings is more than that of the central frame, the mechanical tie-rod must be extended until the machine is completely balanced.



# For every condition

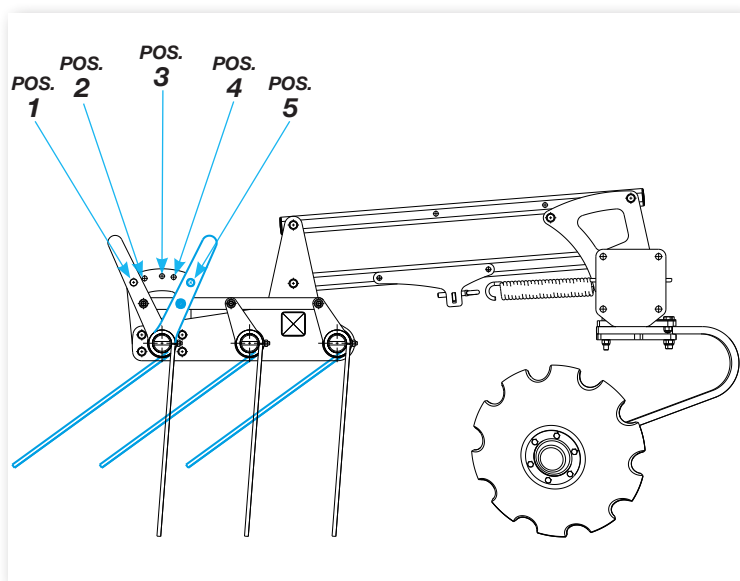

## Hay spreader harrow

The rear harrow can be adjusted in several positions in relation to ground conditions. In very difficult work conditions (such as wet ground, high amounts of residue, etc.), it is possible to exclude the entire harrow in position 5.

Type of ground	Amount of residue	Position
Hard ground	Low	Pos. 2
Hard ground	High	Pos. 2
Loose ground	Low	Pos. 2
Loose ground	High	Pos. 3
Wet ground	Low	Pos. 2
Wet ground	High	Pos. 3

## Rear roller

The rear roller can be set in 2 positions:

**1** - Work position where, thanks to a spring, the pressure exerted on the ground is equal to 170 kg to ensure uniform refining and levelling.

**2** - A pin can be used to lift and exclude the work roller if the ground is too wet to avoid the risk of clogging.

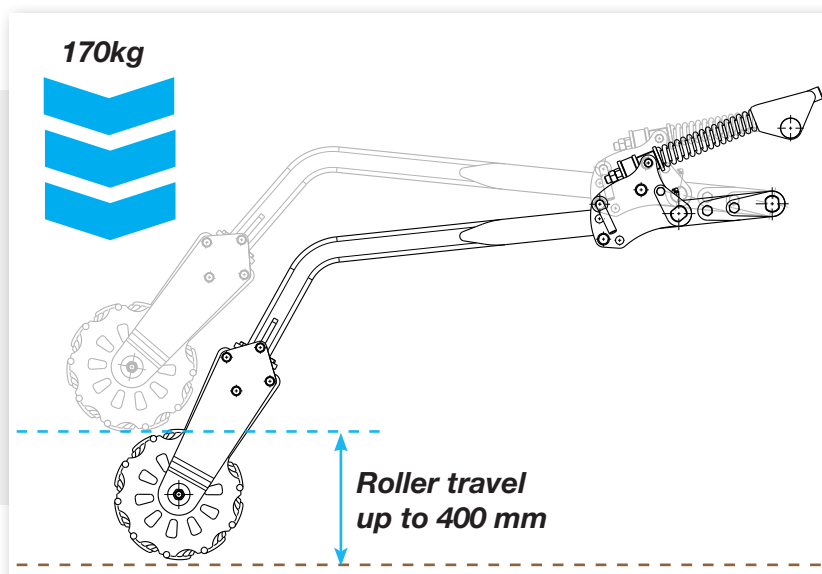

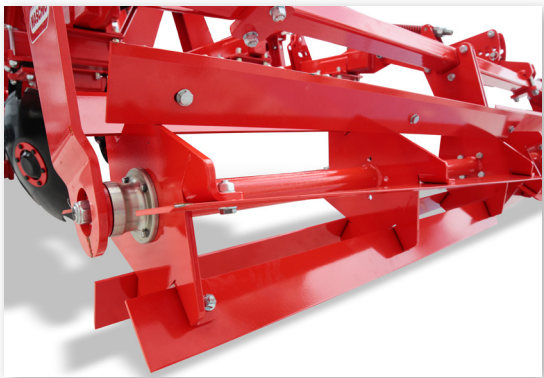

**Blade roller**

For further soil refining, a blade-type rear roller is available that combines the aggressive profile with high rotation speed to enhance the breaking effect.

**Safe transport**

ADMIRAL comprises 3 fold-up sections for a transport length of 4.30 m. The 4 support wheels, together with the drawbar c/w shock-absorber, ensure safe transport even on uneven ground in the countryside.





05-17 Cod. W00226514R  
Maschio Gaspardo Marketing Dept.

**MASCHIO GASPARDO S.p.A.**  
Headquarters and production plant  
Via Marcello, 73  
I-35011 Campodarsego (PADUA) - Italy  
Tel. +39 049 9289810 – Fax +39 049 9289900  
info@maschio.com - www.maschio.com

For graphic reasons, some pictures and images do not show the "EC" safety guards. Technical data and models shown in this catalogue are not binding. We reserve the right to revise the contents of this catalogue, to amend or improve the specifications without notice.