

# MASCHIO



**SUBSOILER RANGE**



# MASCHIO SUBSOILERS

MASCHIO GASPARDO offers a complete, high-quality range of subsoilers that can satisfy any customer. Our subsoilers are available with working widths ranging from 130 to 700 cm, both fixed and folding. The smaller versions are ideal for low-power (50 hp) tractors (even for orchards), while the larger models are perfect for tractors with high power (up to 600 hp).



## **BENEFITS**



- Higher working speed than ploughing
- Good incorporation of the crop residue
- Decompaction and aeration of the soil
- Less erosion and loss of land
- Facilitates water infiltration
- Breaks up the compacted layer just below the tine depth
- No inversion of the layers
- Limited consumption of diesel fuel
- Facilitates root development
- Limited maintenance



# CONTENTS

EFFICIENT AND BENEFICIAL	4
PINOCCHIO	6
ATTILA AND ATTILA HYDRO	8
ARTIGLIO AND ARTIGLIO HYDRO	10
ARTIGLIO MAGNUM AND FOLDING	12
DIABLO	14

## **ARTIGLIO MAGNUM**





# EFFICIENT AND BENEFICIAL

## LESS POOLING AND MORE SAVINGS

Breaking up the soil allows greater percolation of the water towards the deeper layers (with consequent reduction of water pooling) and an improvement of all the physical properties of the soil (in particular its porosity). Thanks to the particular slant of the shanks, it is possible to decrease tensile stress during work, drastically reducing diesel consumption.



## SUBSOILING

- Better development of the basal part
- Deeper roots
- Greater productivity
- Better product quality

## NO MORE COMPACT SOIL

Working 40 to 70 cm deep, the MASCHIO GASPARDO subsoilers guarantee the elimination of the compacted layer just below the tine depth, allowing for an optimal root absorption.

## ROLLERS

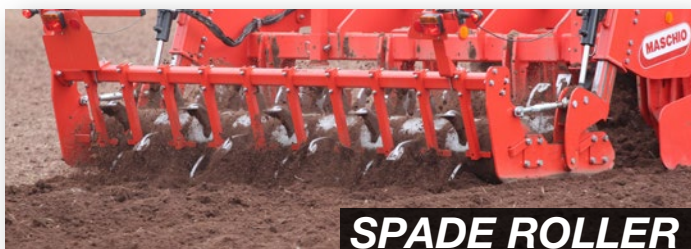

The rollers guarantee a good preparation of the seedbed and at the same time allow the compaction of the ground moved by the shanks, limiting the evaporation of water from the surface layers.

The new double spade roller is available for loose soil, while the classic double spike roller is recommended on stubborn and rich soils.



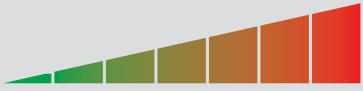

# To work better, you need the right tool!

COATING	BORON STEEL	BORON STEEL WITH TUNGSTEN COATING	WIDIA
USEFUL FOR	Loose terrain without debris	Difficult terrain without debris	Terrains that are sandy, abrasive or rich in debris
VITA			

In addition to perfectly breaking up the deep, compacted layer of soil, the blades allow for an optimal decompaction of the ground in general and the reconstitution of the porosity in all the worked soil, while maintaining a large part of the crop residue on the surface (about 40%), thus protecting the plot against the erosive effect of rain and wind. In the presence of stones it is possible to use the new WIDIA blades that guarantee an increase in durability of about seven times compared to standard blades.

### Clod-breaking blades

The central blade, secured with two elastic pins, breaks up the clods, optimising the soil's refinement.

### Progressive slant

The slant of the shanks has been specifically designed to minimise the strain on the machine.

### Reversible quick-release blade

Given its particular shape, the blade is able to easily break up hard and compacted layers, facilitating the penetration of the shank.

Thanks to the quick-release system with single plug, in a few seconds it is possible to rotate the reversible blade in case of high wear, and if necessary to replace it if completely worn.

### Side coulters

The 140 mm coulters cut the ground horizontally and at high speeds shatter the clods in the top layers of the soil.

The perfect overlap between the two ranks guarantees an optimal result throughout the area. The position of the fins can be adjusted according to the working depth, allowing for better working of the soil.

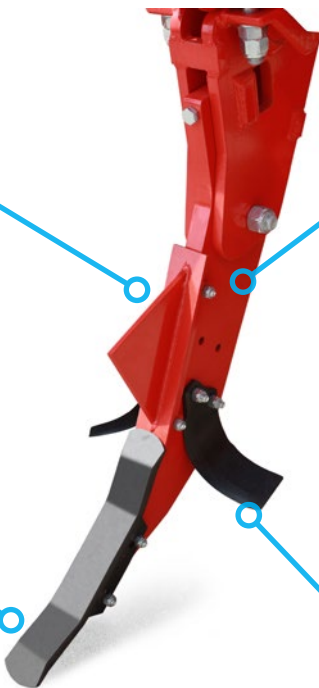

### HYDROPNEUMATIC SYSTEM

The modern safety system and the new shank design ensure correct movement of the element upwards in the event of hidden obstacles, thus preventing damage. By means of a valve system, the oil pushed out of the piston is channelled into a double nitrogen accumulator. Thanks to a pressure gauge it is possible to set the release force of all the shanks.

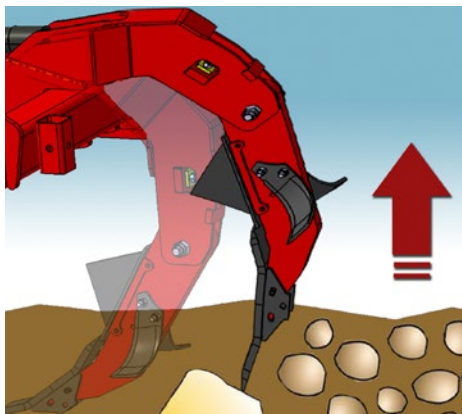

### SHEAR BOLT

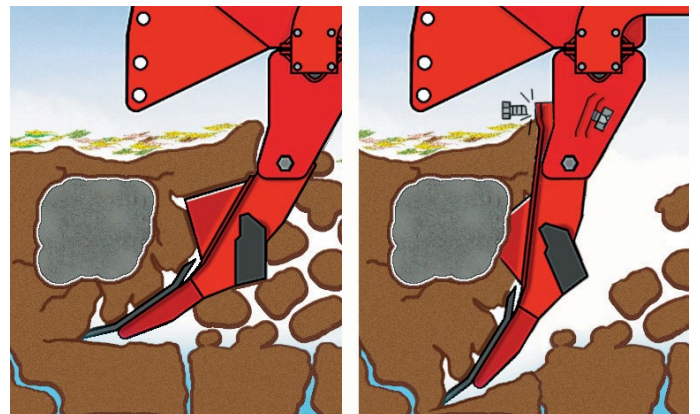

When the maximum load is exceeded, the breaking of the bolt allows the shank to be raised, avoiding possible damage to the shank and the frame.

# PINOCCHIO

from 50 to 160 hp



**PINOCCHIO 2 m**

## **PINOCCHIO**

Designed for medium/low-power tractors (50-160 hp).

The machine works at a maximum depth of 45 cm and is available in different sizes from 1.3 to 3 m, therefore ideal for small farms or simply for those who do not have high-powered tractors.



## **ORCHARD/VINEYARD VERSION**

The models with working widths ranging from 1.3 to 2.5 meters are highly valued for their ability to decompact the spaces between the rows in orchards and vineyards with clayey and asphyxiated soils that in general are compacted by the continuous passage of the tractor.

This way the soil is ventilated for the benefit of the root systems.

## **MECHANICAL ADJUSTMENT OF THE DOUBLE SPIKE ROLLER**

In a few seconds it is possible to change the working depth (pos. 1), the working angle of the rollers (pos. 2) and the distance between the rollers (pos. 3).

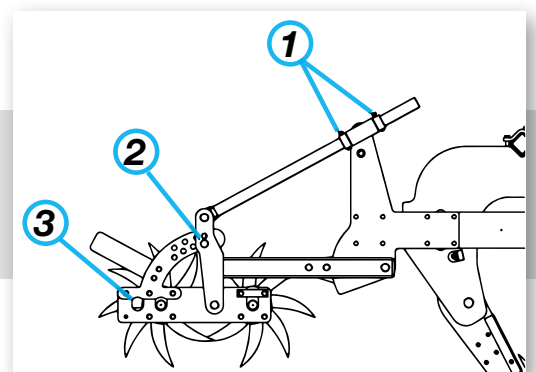



# Suitable for different needs



## HYDRAULIC ROLLER ADJUSTMENT

Upon request, it is possible to have a hydraulic version of the double spike roller, which can be adjusted comfortably from the cab.

## NOT JUST AN ENTRY LEVEL

This subsoiler can mount 3, 5, 7 shanks according to the working width. The shanks have a thickness of 30 mm and a height of 76 cm, qualities that allow PINOCCHIO to work in any condition. The combination of shanks and blades in WIDIA guarantee very high performance.



## VERSATILITY FOR ALL USES

PINOCCHIO mounts a double spike roller that guarantees both a perfect refinement of the previously worked soil and the incorporation of crop residues in the top 15-20 cm of soil. With loose soil it is possible to prepare the soil for sowing in a single pass.

SPECIFICATIONS		PINOCCHIO					
		130/3	170/5	200/5	250/5	250/7	300/7
Tractor power	HP	50-110	70-130	70-130	70-130	100-160	100-160
Working width	cm	130	170	200	250	250	300
Transport width	cm	135	175	205	255	255	300
Number of shanks	n°	3	5	5	5	7	7
Working depth	cm	45	45	45	45	45	45
Weight (mechanical roller)	kg	750	940	1000	1170	1260	1350
Weight (hydraulic roller)	kg	766	975	1022	1090	1180	1275



# **ATTILA** from 110 to 200 hp **ATTILA HYDRO** from 110 to 300 hp



**ATTILA 3 m**

## **ATTILA and ATTILA HYDRO**

The ideal subsoilers for medium-powered tractors, suitable for small- and medium-sized farms. Both allow working the top 50 cm of soil without any inversion of the layers.

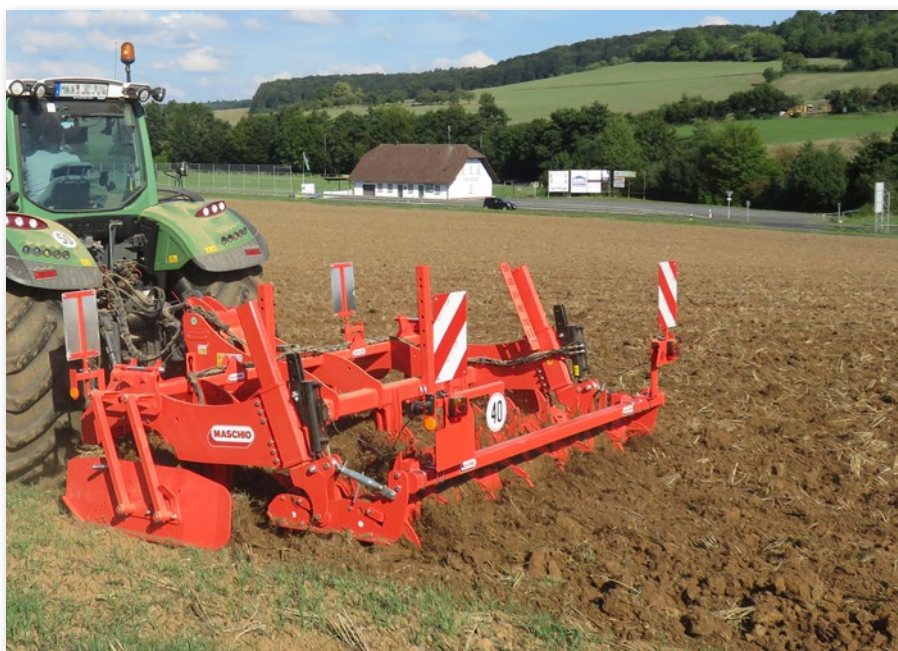

## **PRACTICAL ACCESSORIES**

The containment guards are simple elements but play a very important role in containing the freshly worked soil, avoiding its lateral transfer. They can be moved hydraulically or mechanically.

## **MAXIMUM RESULTS WITH MINIMUM EFFORT**

Thanks to their particular angle of penetration, the shanks sink into the ground progressively, requiring less power from the tractor and generating less stress on the frame.





Well equipped!



*It is advisable to set the pressure of the HYDRO system to 100 bar.*

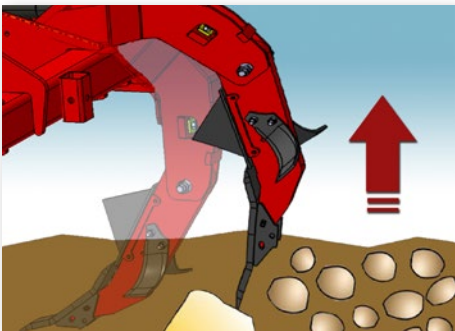

**UNSTOPPABLE**

ATTILA HYDRO can have 5, 6 or 9 shanks with a thickness of 3 cm and a height of 76 cm, which, together with the hydro-pneumatic safety system, allow you to work without any interruption even in soils rich in debris.

**REVERSIBLE BLADES WITH TUNGSTEN CARBIDE COATING**

For abrasive soils with limited debris, the new boron steel blades with a 2 mm tungsten carbide layer are recommended. This tungsten coating, standard for mechanical machines, increases the useful life of the element by reducing the abrasive action.



**FAST**

The ideal working speed is 8-9 km/h. This allows breaking up large surfaces in a short time. With reduced residue, thanks to the double roller (with spikes or spade) it is possible to prepare the seedbed in a single pass.

**FRONT WHEELS**

This option allows keeping a constant working depth.

SPECIFICATIONS		ATTILA			ATTILA HYDRO		
		250/5	300/5	300/7	250/5	300/7	400/9
Tractor power	HP	110-150	120-170	150-200	110-180	150-240	190-300
Working width	cm	250	300	300	250	300	400
Transport width	cm	255	300	300	255	300	415
Number of shanks	n°	5	5	7	5	7	9
Working depth	cm	50	50	50	50	50	50
Weight (mechanical spike roller)	kg	1350	1440	1560	-	-	-
Weight (hydraulic spike roller)	kg	1600	1750	1870	1950	2350	2850
Weight (hydraulic spade roller)	kg	1840	2080	2200	2200	2700	3300



# **ARTIGLIO** from 150 to 390 hp

# **ARTIGLIO HYDRO** from 150 to 350 hp



**ARTIGLIO 3 m**

## **ARTIGLIO and ARTIGLIO HYDRO**

Designed to work with medium/high-powered tractors.

These subsoilers are available in versions of different widths with solutions from 5 to 11 shanks, for a maximum working depth of 55 cm.

## **A FRAME THAT WILL SURPRISE YOU**

The structures of all the frames have been redesigned and improved using new materials able to increase their durability. For all models it is possible to choose from the following frames:

- CSS - with Welded Supports: the shanks are welded to the frame, making the machine lighter
- CSA - with Screwed Supports: each shank is connected to the central frame by 4 or 6 screws, depending on the model



## **NO DOWN TIMES**

The high ground clearance of 86 cm, together with the "wave" design of the sides, ensures an optimal movement of the soil, even with a substantial amount of crop residue, thus avoiding clogging. Thanks to these features and the HYDRO system down times are completely eliminated.



# Never stop!



## HYDRO OFFERS TOP PERFORMANCE

In the HYDRO versions a double safety mechanism is provided thanks to the hydropneumatic system and the shear bolts. In fact, if the pressure applied to the shank should be too high to be tolerated by the HYDRO system alone, the shear bolt will snap, thus avoiding possible breakage.

It is advisable to set the system pressure to 140 bar, because beyond this threshold the shank rises and, once the obstacle has been overcome, it will rearm, returning to working position.



ARTIGLIO and ARTIGLIO HYDRO can be hitched to tractors with a three-point attachment of CAT 3, 4N ISO + 3 and 4N ASAE.

SPECIFICATIONS		ARTIGLIO						ARTIGLIO HYDRO		
		250/5	300/5	300/7	400/7	400/9	500/11	250/5	300/7	400/9
Tractor power	HP	150-200	170-220	190-250	210-270	220-330	250-390	150-250	180-280	250-350
Working width	cm	250	300	300	400	400	500	250	300	400
Transport width	cm	255	300	300	415	415	515	255	300	415
Number of shanks	n°	5	5	7	7	9	11	5	7	9
Working depth	cm	55	55	55	55	55	55	55	55	55
Weight (hydraulic spike roller)	kg	1970	2105	2235	2880	2930	3240	2400	2800	3350
Weight (hydraulic spade roller)	kg	2210	2440	2550	3280	3390	-	2650	3150	3800



# **ARTIGLIO MAGNUM** from 190 to 400 hp **ARTIGLIO FOLDING** from 230 to 400 hp

## **ARTIGLIO FOLDING 5 m**

### **ARTIGLIO FOLDING**

Hydraulic closing system for a reduced transport width (2.55 m), it is available with 4 or 5 m working widths, with 9 or 11 shanks respectively. The particularly robust structure allows it to be used with high-powered wheeled or tracked tractors. Thanks to 4 hydraulic cylinders, it can be closed in a few seconds.

### **IT CAN HANDLE ANYTHING**

Thanks to an 82 cm clearance height, the sturdy 35 mm thick shanks can reach a working depth of 55 cm with excellent results, even with high levels of residue.

### **QUICK ADJUSTMENTS**

The working depth is hydraulically controlled (by crossed hydraulic circuit) through the double roller. The roller is connected to the frame thanks to the new parallelogram attachment, which allows constant contact with the ground even with dips and surface obstacles.



### **CSS FRAME**

The new frame with welded shank supports ensures maximum resistance to shear forces, while the shear bolts protect against collisions and hidden obstacles.

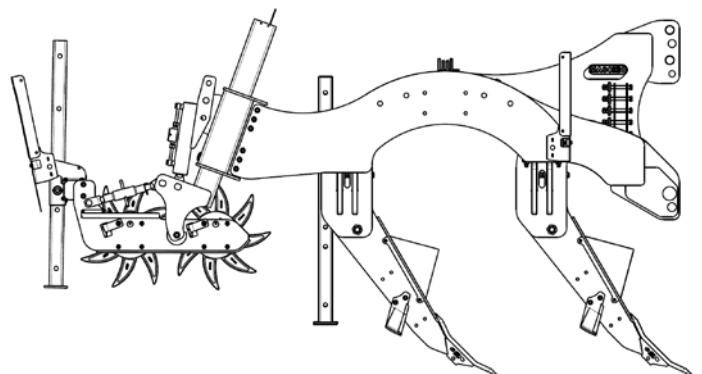



# The right ARTIGLIO for you



## ARTIGLIO MAGNUM

Ideal for high-powered tractors thanks to a high performance frame. With shanks with a thickness of 40 mm and a very high ground clearance (115 cm), it can reach a working depth of 70 cm, offering the top performance in the category.



## MAXIMUM PERFORMANCE WITH "WAVE" DESIGN

With the innovative "wave" design, the sides always guarantee an optimal flow of soil and residue, avoiding blockages even at high working speeds.

SPECIFICATIONS		ARTIGLIO MAGNUM					ARTIGLIO FOLDING	
		250/5	300/5	300/7	400/7	400/9	410/9	500/11
Tractor power	HP	230-340	260-400	190-280	210-310	240-340	260-360	310-400
Working width	cm	410	500	250	300	300	400	400
Transport width	cm	255	255	255	300	300	415	415
Number of shanks	n°	9	11	5	5	7	7	9
Working depth	cm	55	55	70	70	70	70	70
Weight (hydraulic spike roller)	kg	3320	4150	2170	2305	2575	3050	3340
Weight (hydraulic spade roller)	kg	-	-	2395	2645	2915	3475	3765



# **DIABLO** from 400 to 600 hp



**DIABLO 6 m**

## **DIABLO**

With a working width of 5, 6 or 7 m, DIABLO can only be used with tractors of the highest power. The high ground clearance and the combination of shanks and rear discs make it an unstoppable machine in all conditions.

## **HEAVY DUTY FRAME**

With a thickness of 10 mm, the load-bearing frame is incredibly robust. Thanks to 6 hydraulic cylinders (3 per side), the 2 side wings can be quickly closed for road transport. The cylinders also have the function of keeping the machine in a constant working position, avoiding the lifting of the sections or possible damage.



## **TURNING UNDER AND CHOPPING**

The double rear disc roller can also chop up larger clods, making only a light refinement of the soil necessary before sowing.



# Amazing!

Zone 2 consists of a double disc that allows you to reduce the clods created by the shanks, facilitating subsequent operations.

In zone 1 we find two rows of shanks that work the subsoil (down to a depth of 45 cm), breaking up the compacted layer and restoring optimal porosity for the growth of the crops.



### EFFECTIVE AT HIGH SPEEDS

Thanks to the ample working widths and high average speeds (9 km/h), in optimal conditions it is possible to work from 6 to 7 ha/h.

### FOLDING

Despite the size, thanks to its 6 hydraulic cylinders DIABLO folds up in just a few moments.

In the 5 m version the road width is 3 m, while in the 6 and 7 m version it is 3.30 m.



SPECIFICATIONS		DIABLO		
		500/11	600/13	700/15
Tractor power	HP	230-340	260-400	190-280
Working width	cm	410	500	250
Transport width	cm	255	255	255
Number of shanks	n°	9	11	5
Working depth	cm	55	55	70
Weight (hydraulic roller)	kg	3320	4150	2170



